

eltron



Ambalajın Yeni Yüzü

New Face Of Packaging

eltron

The logo for 'eltron' features the word 'eltron' in a bold, white, lowercase sans-serif font. The text is centered and partially enclosed by a light blue, swooping graphic element that forms a partial oval around the letters 'l', 't', 'r', and 'o'.



KURUMSAL TARİHÇE

Eltron Plastik 1999 yılında Türkiye'nin önde gelen bisküvi, çikolata ve şekerleme firmalarına özel gıda ambalajları üreterek gıda ambalajı sektöründe ilk adımını atmıştır. Müşteri odaklı ve verimliliği merkez alan bir yönetim yaklaşımı ile istikrarlı bir büyüme göstererek kısa bir süre içinde PET ve PP gıda kaplarını da portföyüne ekleyerek sektörde lider haline gelmiştir. Termoform gıda ambalajı konusunda kuruluşundan beri süregelen profesyonellik, dürüstlük, tecrübe ve uzman kadro ile sağladığı hizmet bu başarıyı oluşturmuştur.

Teknolojik gelişmeleri yakından takip ederek makine parkını sürekli genişletmekte ve yenilemekte olan Eltron Plastik, yaptığı son yatırımlarla seperatör, sızdırmaz kaplar ve ısıya dayanıklı mikrodalga kapları üretiminde 15000 ton / yıl kapasiteye ulaşmıştır. Standart üretimin yanı sıra müşterilerin ihtiyaçlarına yönelik doğan yeni projelerinde de tam kapsamlı çözümler sunmaktadır. Bu yaklaşımın bir sonucu olarak üretim, satış ve dağıtımında yurt çapında birçok noktaya ulaşan hizmet ağıyla her geçen gün büyümeye devam eden firmamız yurt dışında da 3 kıtada 30 dan fazla ülkeye ihracat gerçekleştirmektedir.

Gıda sektörüne hizmet veren firmaların gıda güvenliğini garanti altına alan BRC kalite belgelerimiz, firmamızın dünya çapında kabul edilen kalite anlayışının garantisidir.

CORPORATE HISTORY

Eltron Plastik, took the first step in the food packaging industry in 1999 by manufacturing bespoke products to the Turkey's leading biscuit, chocolate and confectionery companies. With a customer-oriented and productivity-centered management approach, it became pioneer in the sector by adding PET and PP food containers to its portfolio in a short time. The service provided by professionalism, honesty, experience and expert staff on thermoformed food packaging since its establishment has created this success. Eltron Plastik, which is constantly expanding and renewing its machine park by closely following technological developments reached a capacity of 15000 tons / year in the production of separators, hinged lid food containers and microwaveable meal containers with its latest investments.

As a result of this approach our company which continues to grow day by day with its service network, production, sales and distribution reaching many points throughout the domestic market and exports to more than 30 countries in 3 continents abroad.

Our BRC quality certificates, which guarantee the food safety of the companies serving the food industry, are the guarantee of our company's worldwide accepted quality understanding.

Sızdırmaz Kaplar

Hinged Lid Food Containers





EL 300

150cc Sızdırmaz Kap

150cc Hinged Lid Food Container

Boyutlar/Dimension (LxWxH)

110x120x25

Koli İçi Adedi/Quantity Per Box (pcs)

1000

Koli Ölçüleri/Box Dimensions (LxWxH)(mm)

760x240x560

Koli Hacmi/Box Volume (cbm)

0.1021



EL 301

250cc Sızdırmaz Kap

250cc Hinged Lid Food Container

Boyutlar/Dimension (LxWxH)

110x120x37

Koli İçi Adedi/Quantity Per Box (pcs)

1000

Koli Ölçüleri/Box Dimensions (LxWxH)(mm)

760x240x560

Koli Hacmi/Box Volume (cbm)

0.1021



EL 302

375cc Sızdırmaz Kap

375cc Hinged Lid Food Container

Boyutlar/Dimension (LxWxH)

110x120x53

Koli İçi Adedi/Quantity Per Box (pcs)

1000

Koli Ölçüleri/Box Dimensions (LxWxH)(mm)

760x240x560

Koli Hacmi/Box Volume (cbm)

0.1021



EL 303

500cc Sızdırmaz Kap

500cc Hinged Lid Food Container

Boyutlar/Dimension (LxWxH)

120x135x57

Koli İçi Adedi/Quantity Per Box (pcs)

1000

Koli Ölçüleri/Box Dimensions (LxWxH)(mm)

600x430x540

Koli Hacmi/Box Volume (cbm)

0.1393



EL 304-550

550cc Sızdırmaz Kap

550cc Hinged Lid Food Container

Boyutlar/Dimension (LxWxH)	195x125x39
Koli İçi Adedi/Quantity Per Box (pcs)	600
Koli Ölçüleri/Box Dimensions (LxWxH)(mm)	710x260x595
Koli Hacmi/Box Volume (cbm)	0.110



EL 304

750cc Sızdırmaz Kap

750cc Hinged Lid Food Container

Boyutlar/Dimension (LxWxH)	125x195x53
Koli İçi Adedi/Quantity Per Box (pcs)	600
Koli Ölçüleri/Box Dimensions (LxWxH)(mm)	710x260x595
Koli Hacmi/Box Volume (cbm)	0.1098



EL 305

1000cc Sızdırmaz Kap

1000cc Hinged Lid Food Container

Boyutlar/Dimension (LxWxH)	125x195x70
Koli İçi Adedi/Quantity Per Box (pcs)	600
Koli Ölçüleri/Box Dimensions (LxWxH)(mm)	710x260x595
Koli Hacmi/Box Volume (cbm)	0.1098



EL 306

1250cc Sızdırmaz Kap

1250cc Hinged Lid Food Container

Boyutlar/Dimension (LxWxH)	174x225x58
Koli İçi Adedi/Quantity Per Box (pcs)	400
Koli Ölçüleri/Box Dimensions (LxWxH)(mm)	690x500x455
Koli Hacmi/Box Volume (cbm)	0.1570



EL 307

1500cc Sızdırmaz Kap

1500cc Hinged Lid Food Container

Boyutlar/Dimension (LxWxH)

174x225x68

Koli İçi Adedi/Quantity Per Box (pcs)

400

Koli Ölçüleri/Box Dimensions (LxWxH)(mm)

690x500x455

Koli Hacmi/Box Volume (cbm)

0.1570



EL 308

1750cc Sızdırmaz Kap

1750cc Hinged Lid Food Container

Boyutlar/Dimension (LxWxH)

174x225x80

Koli İçi Adedi/Quantity Per Box (pcs)

400

Koli Ölçüleri/Box Dimensions (LxWxH)(mm)

690x500x455

Koli Hacmi/Box Volume (cbm)

0.1570



EL 309

2000cc Sızdırmaz Kap

2000cc Hinged Lid Food Container

Boyutlar/Dimension (LxWxH)

174x225x88

Koli İçi Adedi/Quantity Per Box (pcs)

400

Koli Ölçüleri/Box Dimensions (LxWxH)(mm)

690x500x455

Koli Hacmi/Box Volume (cbm)

0.1570



EL 304 YK

750cc Yüksek Kapak Sızdırmaz Kap

750cc Hinged High Lid Food Container

Boyutlar/Dimension (LxWxH) 125x195x75

Koli İçi Adedi/Quantity Per Box (pcs) 600

Koli Ölçüleri/Box Dimensions (LxWxH)(mm) 710x260x595

Koli Hacmi/Box Volume (cbm) 0.1098



EL 305 YK

1000cc Yüksek Kapak Sızdırmaz Kap

1000cc Hinged High Lid Food Container

Boyutlar/Dimension (LxWxH) 125x195x90

Koli İçi Adedi/Quantity Per Box (pcs) 600

Koli Ölçüleri/Box Dimensions (LxWxH)(mm) 710x260x595

Koli Hacmi/Box Volume (cbm) 0.1098



EL 306 YK

1250cc Yüksek Kapak Sızdırmaz Kap

1250cc Hinged High Lid Food Container

Boyutlar/Dimension (LxWxH) 174x225x78

Koli İçi Adedi/Quantity Per Box (pcs) 400

Koli Ölçüleri/Box Dimensions (LxWxH)(mm) 690x500x455

Koli Hacmi/Box Volume (cbm) 0.1570



EL 307 YK

1500cc Yüksek Kapak Sızdırmaz Kap

1500cc Hinged High Lid Food Container

Boyutlar/Dimension (LxWxH) 174x225x88

Koli İçi Adedi/Quantity Per Box (pcs) 400

Koli Ölçüleri/Box Dimensions (LxWxH)(mm) 690x500x455

Koli Hacmi/Box Volume (cbm) 0.1570



EL 308 YK

1750cc Yüksek Kapak Sızdırmaz Kap

1750cc Hinged High Lid Food Container

Boyutlar/Dimension (LxWxH) 174x225x100

Koli İçi Adedi/Quantity Per Box (pcs) 400

Koli Ölçüleri/Box Dimensions (LxWxH)(mm) 690x500x455

Koli Hacmi/Box Volume (cbm) 0.1570



EL 309 YK

2000cc Yüksek Kapak Sızdırmaz Kap

2000cc Hinged High Lid Food Container

Boyutlar/Dimension (LxWxH) 174x225x108

Koli İçi Adedi/Quantity Per Box (pcs) 400

Koli Ölçüleri/Box Dimensions (LxWxH)(mm) 690x500x455

Koli Hacmi/Box Volume (cbm) 0.1570



EL 400

150cc Lüks Sızdırmaz Kap

150cc Lux Hinged Lid Food Container

Boyutlar/Dimension (LxWxH) 110x120x25

Koli İçi Adedi/Quantity Per Box (pcs) 1000

Koli Ölçüleri/Box Dimensions (LxWxH)(mm) 555x455x480

Koli Hacmi/Box Volume (cbm) 0.1210



EL 401

250cc Lüks Sızdırmaz Kap

250cc Lux Hinged Lid Food Container

Boyutlar/Dimension (LxWxH) 110x120x37

Koli İçi Adedi/Quantity Per Box (pcs) 500

Koli Ölçüleri/Box Dimensions (LxWxH)(mm) 555x430x240

Koli Hacmi/Box Volume (cbm) 0.0570



EL 401-BK

250cc Bombe Kapak Sızdırmaz Kap

250cc Lux Hinged Dome Lid Food Container

Boyutlar/Dimension (LxWxH) 108x116x56

Koli İçi Adedi/Quantity Per Box (pcs) 500

Koli Ölçüleri/Box Dimensions (LxWxH)(mm) 555x430x240

Koli Hacmi/Box Volume (cbm) 0.0572



EL 402

375cc Lüks Sızdırmaz Kap

375cc Lux Hinged Lid Food Container

Boyutlar/Dimension (LxWxH) 110x120x53

Koli İçi Adedi/Quantity Per Box (pcs) 1000

Koli Ölçüleri/Box Dimensions (LxWxH)(mm) 555x455x480

Koli Hacmi/Box Volume (cbm) 0.1210



EL 403

500cc Lüks Sızdırmaz Kap

500cc Lux Hinged Lid Food Container

Boyutlar/Dimension (LxWxH)

120x135x57

Koli İçi Adedi/Quantity Per Box (pcs)

600

Koli Ölçüleri/Box Dimensions (LxWxH)(mm)

525x525x385

Koli Hacmi/Box Volume (cbm)

0.1060



EL 404

750cc Lüks Sızdırmaz Kap

750cc Lux Hinged Lid Food Container

Boyutlar/Dimension (LxWxH)

125x195x53

Koli İçi Adedi/Quantity Per Box (pcs)

600

Koli Ölçüleri/Box Dimensions (LxWxH)(mm)

600x265x800

Koli Hacmi/Box Volume (cbm)

0.1270



EL 405

1000cc Lüks Sızdırmaz Kap

1000cc Lux Hinged Lid Food Container

Boyutlar/Dimension (LxWxH)

125x195x70

Koli İçi Adedi/Quantity Per Box (pcs)

600

Koli Ölçüleri/Box Dimensions (LxWxH)(mm)

600x265x800

Koli Hacmi/Box Volume (cbm)

0.1270



EL 406

1250cc Lüks Sızdırmaz Kap

1250cc Lux Hinged Lid Food Container

Boyutlar/Dimension (LxWxH)

174x225x58

Koli İçi Adedi/Quantity Per Box (pcs)

400

Koli Ölçüleri/Box Dimensions (LxWxH)(mm)

685x530x455

Koli Hacmi/Box Volume (cbm)

0.1610



EL 407

1500cc Lux Sızdırmaz Kap

1500cc Lux Hinged Lid Food Container

Boyutlar/Dimension (LxWxH)

174x225x68

Koli İçi Adedi/Quantity Per Box (pcs)

400

Koli Ölçüleri/Box Dimensions (LxWxH)(mm)

685x530x455

Koli Hacmi/Box Volume (cbm)

0.1610



EL 408

1750cc Lux Sızdırmaz Kap

1750cc Lux Hinged Lid Food Container

Boyutlar/Dimension (LxWxH)

174x225x80

Koli İçi Adedi/Quantity Per Box (pcs)

400

Koli Ölçüleri/Box Dimensions (LxWxH)(mm)

685x530x455

Koli Hacmi/Box Volume (cbm)

0.1610



EL 409

2000cc Lux Sızdırmaz Kap

2000cc Lux Hinged Lid Food Container

Boyutlar/Dimension (LxWxH)

174x225x88

Koli İçi Adedi/Quantity Per Box (pcs)

400

Koli Ölçüleri/Box Dimensions (LxWxH)(mm)

685x530x455

Koli Hacmi/Box Volume (cbm)

0.1610



EL 350

80cc Oval Sızdırmaz Kap

80cc Oval Minibar Hinged Lid Food Container

Boyutlar/Dimension (LxWxH) 93x112x25
Koli İçi Adedi/Quantity Per Box (pcs) 1000
Koli Ölçüleri/Box Dimensions (LxWxH)(mm) 560x415x350
Koli Hacmi/Box Volume (cbm) 0.810



EL 351

100cc Oval Sızdırmaz Kap

100cc Oval Minibar Hinged Lid Food Container

Boyutlar/Dimension (LxWxH) 93x112x31
Koli İçi Adedi/Quantity Per Box (pcs) 1000
Koli Ölçüleri/Box Dimensions (LxWxH)(mm) 560x415x350
Koli Hacmi/Box Volume (cbm) 0.0810



EL 352-1

150cc Oval Sızdırmaz Kap

150cc Oval Minibar Hinged Lid Food Container

Boyutlar/Dimension (LxWxH) 84x109x40
Koli İçi Adedi/Quantity Per Box (pcs) 1000
Koli Ölçüleri/Box Dimensions (LxWxH)(mm) 550x355x455
Koli Hacmi/Box Volume (cbm) 0.0888



EL 352

150cc Oval Sızdırmaz Kap

150cc Oval Hinged Lid Food Container

Boyutlar/Dimension (LxWxH) 112x145x26
Koli İçi Adedi/Quantity Per Box (pcs) 800
Koli Ölçüleri/Box Dimensions (LxWxH)(mm) 510x460x590
Koli Hacmi/Box Volume (cbm) 0.1384



EL 353

250cc Oval Sızdırmaz Kap

250cc Oval Hinged Lid Food Container

Boyutlar/Dimension (LxWxH) 112x145x42
Koli İçi Adedi/Quantity Per Box (pcs) 800
Koli Ölçüleri/Box Dimensions (LxWxH)(mm) 510x460x590
Koli Hacmi/Box Volume (cbm) 0.1384



EL 354

375cc Oval Sızdırmaz Kap

375cc Oval Hinged Lid Food Container

Boyutlar/Dimension (LxWxH)

112x145x57

Koli İçi Adedi/Quantity Per Box (pcs)

800

Koli Ölçüleri/Box Dimensions (LxWxH)(mm)

510x460x590

Koli Hacmi/Box Volume (cbm)

0.1384



EL 355

500cc Oval Sızdırmaz Kap

500cc Oval Hinged Lid Food Container

Boyutlar/Dimension (LxWxH)

127x160x57

Koli İçi Adedi/Quantity Per Box (pcs)

600

Koli Ölçüleri/Box Dimensions (LxWxH)(mm)

580x490x520

Koli Hacmi/Box Volume (cbm)

0.1478



EL 356

750cc Oval Sızdırmaz Kap

750cc Oval Hinged Lid Food Container

Boyutlar/Dimension (LxWxH)

145x190x60

Koli İçi Adedi/Quantity Per Box (pcs)

400

Koli Ölçüleri/Box Dimensions (LxWxH)(mm)

565x395x585

Koli Hacmi/Box Volume (cbm)

0.1305



EL 357

1000cc Oval Sızdırmaz Kap

1000cc Oval Hinged Lid Food Container

Boyutlar/Dimension (LxWxH)

145x190x82

Koli İçi Adedi/Quantity Per Box (pcs)

400

Koli Ölçüleri/Box Dimensions (LxWxH)(mm)

565x395x585

Koli Hacmi/Box Volume (cbm)

0.1305



EL 358

3 Gözlü Oval Sızdırmaz Kap

3 Compartment Oval Hinged Lid Food Container

Boyutlar/Dimension (LxWxH)

194x143x30

Koli İçi Adedi/Quantity Per Box (pcs)

400

Koli Ölçüleri/Box Dimensions (LxWxH)(mm)

565x395x585

Koli Hacmi/Box Volume (cbm)

0.1305

Yuvarlak Sızdırmaz Kaplar

Round Hinged Lid Salad Containers





EL 360

250cc Yuvarlak Sızdırmaz Kap

250cc Round Hinged Lid Food Container

Boyutlar/Dimension (LxWxH)

Ø125 H:63

Koli İçi Adedi/Quantity Per Box (pcs)

600

Koli Ölçüleri/Box Dimensions (LxWxH)(mm)

525x525x385

Koli Hacmi/Box Volume (cbm)

0.1061



EL 361

375cc Yuvarlak Sızdırmaz Kap

375cc Round Hinged Lid Food Container

Boyutlar/Dimension (LxWxH)

Ø133 H:75

Koli İçi Adedi/Quantity Per Box (pcs)

600

Koli Ölçüleri/Box Dimensions (LxWxH)(mm)

545x425x555

Koli Hacmi/Box Volume (cbm)

0.1286



EL 362

500cc Yuvarlak Sızdırmaz Kap

500cc Round Hinged Lid Food Container

Boyutlar/Dimension (LxWxH)

Ø155 H:80

Koli İçi Adedi/Quantity Per Box (pcs)

600

Koli Ölçüleri/Box Dimensions (LxWxH)(mm)

615x530x450

Koli Hacmi/Box Volume (cbm)

0.1467



EL 363

750cc Yuvarlak Sızdırmaz Kap

750cc Round Hinged Lid Food Container

Boyutlar/Dimension (LxWxH)

Ø170 H:87

Koli İçi Adedi/Quantity Per Box (pcs)

400

Koli Ölçüleri/Box Dimensions (LxWxH)(mm)

675x525x355

Koli Hacmi/Box Volume (cbm)

0.1258



EL 364

1000cc Yuvarlak Sızdırmaz Kap

1000cc Round Hinged Lid Food Container

Boyutlar/Dimension (LxWxH)

Ø185 H:93

Koli İçi Adedi/Quantity Per Box (pcs)

400

Koli Ölçüleri/Box Dimensions (LxWxH)(mm)

520x375x725

Koli Hacmi/Box Volume (cbm)

0.1414



EL 365

820cc Yuvarlak Sızdırmaz Kap

820cc Round Hinged Lid Food Container

Boyutlar/Dimension (LxWxH)

Ø175 H:84.5

Koli İçi Adedi/Quantity Per Box (pcs)

252

Koli Ölçüleri/Box Dimensions (LxWxH)(mm)

690x370x530

Koli Hacmi/Box Volume (cbm)

0.1350



EL 366

1070cc Yuvarlak Sızdırmaz Kap

1070cc Round Hinged Lid Food Container

Boyutlar/Dimension (LxWxH)

Ø175 H:100

Koli İçi Adedi/Quantity Per Box (pcs)

252

Koli Ölçüleri/Box Dimensions (LxWxH)(mm)

690x370x530

Koli Hacmi/Box Volume (cbm)

0.1350



EL 310

500cc Federli Peynir Kabı

500cc Cheese Container

Boyutlar/Dimension (LxWxH)

115x155x88

Koli İçi Adedi/Quantity Per Box (pcs)

1000

Koli Ölçüleri/Box Dimensions (LxWxH)(mm)

775x455x465

Koli Hacmi/Box Volume (cbm)

0.1640



EL 310-1

500cc Peynir Kabı

500cc Cheese Container

Boyutlar/Dimension (LxWxH)

115x155x88

Koli İçi Adedi/Quantity Per Box (pcs)

1000

Koli Ölçüleri/Box Dimensions (LxWxH)(mm)

775x455x465

Koli Hacmi/Box Volume (cbm)

0.1640



EL 410

500cc Peynir Kabı

500cc Cheese Container

Boyutlar/Dimension (LxWxH)

115x155x88

Koli İçi Adedi/Quantity Per Box (pcs)

1000

Koli Ölçüleri/Box Dimensions (LxWxH)(mm)

500x450x625

Koli Hacmi/Box Volume (cbm)

0.1400



EL 311

500cc Federsiz Peynir Kabı

500cc Cheese Container

Boyutlar/Dimension (LxWxH)

115x155x88

Koli İçi Adedi/Quantity Per Box (pcs)

800

Koli Ölçüleri/Box Dimensions (LxWxH)(mm)

500x455x625

Koli Hacmi/Box Volume (cbm)

0.1422



EL 312

500cc Federsiz Düz Peynir Kabı

500cc Cheese Container

Boyutlar/Dimension (LxWxH)

115x155x50

Koli İçi Adedi/Quantity Per Box (pcs)

800

Koli Ölçüleri/Box Dimensions (LxWxH)(mm)

500x450x625

Koli Hacmi/Box Volume (cbm)

0.1410



EL 313

250cc Federsiz Düz Peynir Kabı

250cc Cheese Container

Boyutlar/Dimension (LxWxH)

115x155x40

Koli İçi Adedi/Quantity Per Box (pcs)

800

Koli Ölçüleri/Box Dimensions (LxWxH)(mm)

500x450x625

Koli Hacmi/Box Volume (cbm)

0.1410



EL 314

1000cc Federsiz Düz Peynir Kabı

1000cc Cheese Container

Boyutlar/Dimension (LxWxH)

125x195x70

Koli İçi Adedi/Quantity Per Box (pcs)

600

Koli Ölçüleri/Box Dimensions (LxWxH)(mm)

500x450x625

Koli Hacmi/Box Volume (cbm)

0.1410

Sos Kaplari

Hinged Lid Sauce Containers





EL 330

20cc Sos Kabi

20cc Hinged Lid Sauce Container

Boyutlar/Dimension (LxWxH)

43x65x20

Koli İçi Adedi/Quantity Per Box (pcs)

2000

Koli Ölçüleri/Box Dimensions (LxWxH)(mm)

535x430x245

Koli Hacmi/Box Volume (cbm)

0.0564



EL 331

30cc Sos Kabi

30cc Hinged Lid Sauce Container

Boyutlar/Dimension (LxWxH)

43x65x25

Koli İçi Adedi/Quantity Per Box (pcs)

2000

Koli Ölçüleri/Box Dimensions (LxWxH)(mm)

535x430x245

Koli Hacmi/Box Volume (cbm)

0.0564



EL 332

50cc Sos Kabi

50cc Hinged Lid Sauce Container

Boyutlar/Dimension (LxWxH)

60x86x26

Koli İçi Adedi/Quantity Per Box (pcs)

1200

Koli Ölçüleri/Box Dimensions (LxWxH)(mm)

370x540x370

Koli Hacmi/Box Volume (cbm)

0.0734



EL 333

60cc Sos Kabi

60cc Hinged Lid Sauce Container

Boyutlar/Dimension (LxWxH)

60x86x30

Koli İçi Adedi/Quantity Per Box (pcs)

1200

Koli Ölçüleri/Box Dimensions (LxWxH)(mm)

370x540x370

Koli Hacmi/Box Volume (cbm)

0.0734



EL 334

80cc Sos Kabi

80cc Hinged Lid Sauce Container

Boyutlar/Dimension (LxWxH)

60x86x38

Koli İçi Adedi/Quantity Per Box (pcs)

1200

Koli Ölçüleri/Box Dimensions (LxWxH)(mm)

370x540x370

Koli Hacmi/Box Volume (cbm)

0.0734

Şarküteri Kapları

PP Food Containers



**EL 610 C-KAPAK****Çorba Kapak**

Soup Lid

Boyutlar/Dimension (LxWxH) $\emptyset 100$ xH:8,5
 Koli İçi Adedi/Quantity Per Box (pcs) 1000
 Koli Ölçüleri/Box Dimensions (LxWxH)(mm) 585x335x480
 Koli Hacmi/Box Volume (cbm) 0.094

**EL 242****Ø100 Düz Kapak**

Ø100 Flat Lid

Boyutlar/Dimension (LxWxH) $\emptyset 102$ H:8
 Koli İçi Adedi/Quantity Per Box (pcs) 2000
 Koli Ölçüleri/Box Dimensions (LxWxH)(mm) 530x405x505
 Koli Hacmi/Box Volume (cbm) 0.1084

**EL 243****Ø100 Bombe Kapak**

Ø100 Dome Lid

Boyutlar/Dimension (LxWxH) $\emptyset 104$ H:28
 Koli İçi Adedi/Quantity Per Box (pcs) 2000
 Koli Ölçüleri/Box Dimensions (LxWxH)(mm) 530x405x505
 Koli Hacmi/Box Volume (cbm) 0.1084

**EL 248****150cc PP Sup Kase**

150cc PP Soup Bowl

Boyutlar/Dimension (LxWxH) $\emptyset 100$ H:34
 Koli İçi Adedi/Quantity Per Box (pcs) 2000
 Koli Ölçüleri/Box Dimensions (LxWxH)(mm) 530x405x505
 Koli Hacmi/Box Volume (cbm) 0.1084

**EL 249****200cc Sup Kase**

200cc PP Soup Bowl

Boyutlar/Dimension (LxWxH) $\emptyset 100$ H:40
 Koli İçi Adedi/Quantity Per Box (pcs) 2000
 Koli Ölçüleri/Box Dimensions (LxWxH)(mm) 530x405x505
 Koli Hacmi/Box Volume (cbm) 0.1084



EL 244

250 Gr PP Kap

250 Gr PP Food Tray

Boyutlar/Dimension (LxWxH)	105x142x37
Koli İçi Adedi/Quantity Per Box (pcs)	2000
Koli Ölçüleri/Box Dimensions (LxWxH)(mm)	660x525x560
Koli Hacmi/Box Volume (cbm)	0.1940



EL 245

500 Gr PP Kap

500 Gr PP Food Tray

Boyutlar/Dimension (LxWxH)	105x197x35
Koli İçi Adedi/Quantity Per Box (pcs)	1200
Koli Ölçüleri/Box Dimensions (LxWxH)(mm)	675x425x595
Koli Hacmi/Box Volume (cbm)	0.1707



EL 246

500 Gr PP Derin Kap

500 Gr PP Food Tray

Boyutlar/Dimension (LxWxH)	105x142x62
Koli İçi Adedi/Quantity Per Box (pcs)	2000
Koli Ölçüleri/Box Dimensions (LxWxH)(mm)	660x525x560
Koli Hacmi/Box Volume (cbm)	0.1940



EL 247

1000 Gr PP Kap

1000 Gr PP Food Tray

Boyutlar/Dimension (LxWxH)	105x197x70
Koli İçi Adedi/Quantity Per Box (pcs)	1200
Koli Ölçüleri/Box Dimensions (LxWxH)(mm)	675x425x595
Koli Hacmi/Box Volume (cbm)	0.1707

Baklava ve Kurabiye Kapları

Desert and Cookie Containers





EL 315

Bombe Kapak Kurabiye Kabi

High Lid Cookie Container

Boyutlar/Dimension (LxWxH) 140x205x65
Koli İçi Adedi/Quantity Per Box (pcs) 360
Koli Ölçüleri/Box Dimensions (LxWxH)(mm) 570x500x430
Koli Hacmi/Box Volume (cbm) 0.1226



EL 316

Bombe Kapak Kurabiye Kabi

High Lid Cookie Container

Boyutlar/Dimension (LxWxH) 140x205x60
Koli İçi Adedi/Quantity Per Box (pcs) 360
Koli Ölçüleri/Box Dimensions (LxWxH)(mm) 570x500x430
Koli Hacmi/Box Volume (cbm) 0.1226



EL 317

Bombe Kapak Kurabiye Kabi

High Lid Cookie Container

Boyutlar/Dimension (LxWxH) 140x205x55
Koli İçi Adedi/Quantity Per Box (pcs) 360
Koli Ölçüleri/Box Dimensions (LxWxH)(mm) 570x500x430
Koli Hacmi/Box Volume (cbm) 0.1226



EL 318

Düz Kapak Kurabiye Kabi

Flat Lid Cookie Container

Boyutlar/Dimension (LxWxH) 140x205x45
Koli İçi Adedi/Quantity Per Box (pcs) 360
Koli Ölçüleri/Box Dimensions (LxWxH)(mm) 570x500x430
Koli Hacmi/Box Volume (cbm) 0.1226

**EL 319****1000 Gr Yüksek Kapak Kurabiye Kabi**

1000 Gr High Lid Cookie Container

Boyutlar/Dimension (LxWxH)	150x215x80
Koli İçi Adedi/Quantity Per Box (pcs)	400
Koli Ölçüleri/Box Dimensions (LxWxH)(mm)	550x430x610
Koli Hacmi/Box Volume (cbm)	0.1442

**EL 319-D****Düz Kapak Kurabiye Kabi**

Flat Lid Cookie Container

Boyutlar/Dimension (LxWxH)	140x205x40
Koli İçi Adedi/Quantity Per Box (pcs)	400
Koli Ölçüleri/Box Dimensions (LxWxH)(mm)	550x430x610
Koli Hacmi/Box Volume (cbm)	0.1442

**EL 320****Düz Kapak Kurabiye Kabi**

Flat Lid Cookie Container

Boyutlar/Dimension (LxWxH)	140x205x40
Koli İçi Adedi/Quantity Per Box (pcs)	360
Koli Ölçüleri/Box Dimensions (LxWxH)(mm)	570x500x430
Koli Hacmi/Box Volume (cbm)	0.1225

**EL 340****500 Gr Yüksek Kapak Kurabiye Kabi**

500 Gr High Lid Cookie Container

Boyutlar/Dimension (LxWxH)	150x215x47
Koli İçi Adedi/Quantity Per Box (pcs)	400
Koli Ölçüleri/Box Dimensions (LxWxH)(mm)	550x430x610
Koli Hacmi/Box Volume (cbm)	0.144



EL 167

750cc Kurabiye Kabi

750cc Cookie Container With Snap Lock

Boyutlar/Dimension (LxWxH)	160x217x32
Koli İçi Adedi/Quantity Per Box (pcs)	200
Koli Ölçüleri/Box Dimensions (LxWxH)(mm)	600x350x240
Koli Hacmi/Box Volume (cbm)	0.0504



EL 339

250 Gr Kurabiye Kabi

250 Gr Cookie Container

Boyutlar/Dimension (LxWxH)	115x225x40
Koli İçi Adedi/Quantity Per Box (pcs)	400
Koli Ölçüleri/Box Dimensions (LxWxH)(mm)	507x445x450
Koli Hacmi/Box Volume (cbm)	0.1226



EL325-KK

Kare Kurabiye Kabi

Square Cookie Container

Boyutlar/Dimension (LxWxH)	185x185x62
Koli İçi Adedi/Quantity Per Box (pcs)	200
Koli Ölçüleri/Box Dimensions (LxWxH)(mm)	560x380x400
Koli Hacmi/Box Volume (cbm)	0.08512



EL325-GÖVDE

Kare Kurabiye Gövde

Square Cookie Container

Boyutlar/Dimension (LxWxH)	185x185x42
Koli İçi Adedi/Quantity Per Box (pcs)	420
Koli Ölçüleri/Box Dimensions (LxWxH)(mm)	560x380x400
Koli Hacmi/Box Volume (cbm)	0.08512



EL325-KAPAK

Kare Kurabiye Kapak

Square Cookie Container Lid

Boyutlar/Dimension (LxWxH)	185x185x20
Koli İçi Adedi/Quantity Per Box (pcs)	480
Koli Ölçüleri/Box Dimensions (LxWxH)(mm)	560x380x400
Koli Hacmi/Box Volume (cbm)	0.08512

**EL 326****500 Gr Yüksek Kapak Baklava Kabı**

500 Gr High Lid Baklava Container

Boyutlar/Dimension (LxWxH)	247x160x45
Koli İçi Adedi/Quantity Per Box (pcs)	400
Koli Ölçüleri/Box Dimensions (LxWxH)(mm)	650x550x510
Koli Hacmi/Box Volume (cbm)	0.1823

**EL 327****500 Gr Baklava Kabı**

500 Gr Baklava Container

Boyutlar/Dimension (LxWxH)	160x247x45
Koli İçi Adedi/Quantity Per Box (pcs)	400
Koli Ölçüleri/Box Dimensions (LxWxH)(mm)	640x520x510
Koli Hacmi/Box Volume (cbm)	0.1700

**EL 328****1000 Gr Baklava Kabı**

1000 Gr Baklava Container

Boyutlar/Dimension (LxWxH)	217x290x45
Koli İçi Adedi/Quantity Per Box (pcs)	200
Koli Ölçüleri/Box Dimensions (LxWxH)(mm)	545x445x605
Koli Hacmi/Box Volume (cbm)	0.1470

**EL 283****Baklava Seperatörü**

Baklava Tray

Boyutlar/Dimension (LxWxH)	220x130x21
Koli İçi Adedi/Quantity Per Box (pcs)	1040
Koli Ölçüleri/Box Dimensions (LxWxH)(mm)	600x490x500
Koli Hacmi/Box Volume (cbm)	0.147

Yumurta Viyolleri

Egg Trays



**EL 380****Bıldırcın Yumurta Viyölü**

Quail Egg Tray

Boyutlar/Dimension (LxWxH)	125x100x40
Koli İçi Adedi/Quantity Per Box (pcs)	1200
Koli Ölçüleri/Box Dimensions (LxWxH)(mm)	540x435x515
Koli Hacmi/Box Volume (cbm)	0.1209

**EL 381****15'li Yumurta Viyölü**

15 Pcs Egg Tray

Boyutlar/Dimension (LxWxH)	150x245x73
Koli İçi Adedi/Quantity Per Box (pcs)	400
Koli Ölçüleri/Box Dimensions (LxWxH)(mm)	500x405x627
Koli Hacmi/Box Volume (cbm)	0.1270

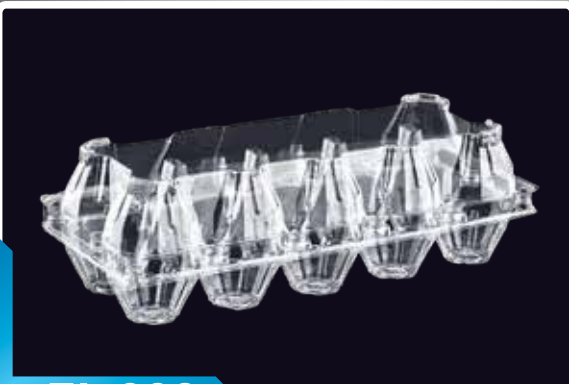
**EL 382****10'lu Yumurta Viyölü**

10 Pcs Egg tray

Boyutlar/Dimension (LxWxH)	100x240x73
Koli İçi Adedi/Quantity Per Box (pcs)	400
Koli Ölçüleri/Box Dimensions (LxWxH)(mm)	510x445x450
Koli Hacmi/Box Volume (cbm)	0.1021

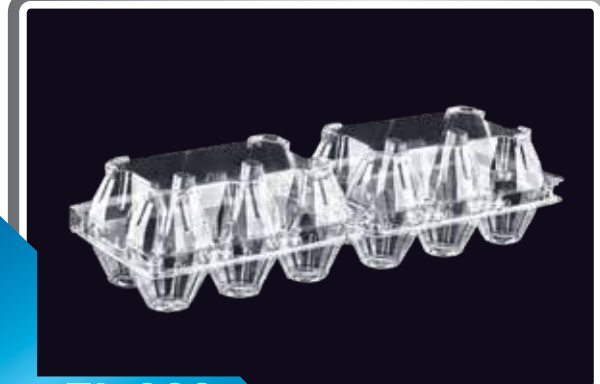
**EL 383****6x2 Yumurta Viyölü**

6x2 Pcs Egg Tray

Boyutlar/Dimension (LxWxH)	100x295x73
Koli İçi Adedi/Quantity Per Box (pcs)	400
Koli Ölçüleri/Box Dimensions (LxWxH)(mm)	570x500x470
Koli Hacmi/Box Volume (cbm)	0.1339



EL 160

Bölmeli Salata Kabi

2 Compartment Salad Container

Boyutlar/Dimension (LxWxH)

180x180x70

Koli İçi Adedi/Quantity Per Box (pcs)

320

Koli Ölçüleri/Box Dimensions (LxWxH)(mm)

560x380x400

Koli Hacmi/Box Volume (cbm)

0.8512



EL 161

Salata Kabi Sos Seperatörü

Salad Container Sauce Separator

Boyutlar/Dimension (LxWxH)

160x56x16

Koli İçi Adedi/Quantity Per Box (pcs)

4500

Koli Ölçüleri/Box Dimensions (LxWxH)(mm)

600x490x500

Koli Hacmi/Box Volume (cbm)

0.1470



EL373-S

750cc Kare Salata Kabi

750cc Square Salad Container

Boyutlar/Dimension (LxWxH)

190x190x50

Koli İçi Adedi/Quantity Per Box (pcs)

400

Koli Ölçüleri/Box Dimensions (LxWxH)(mm)

795x390x390

Koli Hacmi/Box Volume (cbm)

0.1209



EL373-S

750cc Kare Salata Kabi

750cc Square Salad Container

Boyutlar/Dimension (LxWxH)

190x190x50

Koli İçi Adedi/Quantity Per Box (pcs)

400

Koli Ölçüleri/Box Dimensions (LxWxH)(mm)

795x390x390

Koli Hacmi/Box Volume (cbm)

0.1209



EL373-Y

750cc Kare Salata Kabi

750cc Square Salad Container

Boyutlar/Dimension (LxWxH)

190x190x50

Koli İçi Adedi/Quantity Per Box (pcs)

400

Koli Ölçüleri/Box Dimensions (LxWxH)(mm)

795x390x390

Koli Hacmi/Box Volume (cbm)

0.1209

**EL374-S****1000cc Kare Salata Kabı**

1000cc Square Salad Container

Boyutlar/Dimension (LxWxH) 190x190x65

Koli İçi Adedi/Quantity Per Box (pcs) 400

Koli Ölçüleri/Box Dimensions (LxWxH)(mm) 795x390x390

Koli Hacmi/Box Volume (cbm) 0.1209

**EL374-S****1000cc Kare Salata Kabı**

1000cc Square Salad Container

Boyutlar/Dimension (LxWxH) 190x190x65

Koli İçi Adedi/Quantity Per Box (pcs) 400

Koli Ölçüleri/Box Dimensions (LxWxH)(mm) 795x390x390

Koli Hacmi/Box Volume (cbm) 0.1209

**EL374-Y****1000cc Kare Yeşil Salata Kabı**

1000cc Square Salad Container

Boyutlar/Dimension (LxWxH) 190x190x65

Koli İçi Adedi/Quantity Per Box (pcs) 400

Koli Ölçüleri/Box Dimensions (LxWxH)(mm) 795x390x390

Koli Hacmi/Box Volume (cbm) 0.1209

**EL375****Kare Salata Kapağı**

Square Salad Container Lid

Boyutlar/Dimension (LxWxH) 190x190x26

Koli İçi Adedi/Quantity Per Box (pcs) 400

Koli Ölçüleri/Box Dimensions (LxWxH)(mm) 583x390x375

Koli Hacmi/Box Volume (cbm) 0.0850

Mikrodalga Yemek Kaplari

Microwaveable Meal Containers





EL376-GÖVDE-SİYAH

Tek Bölmeli Mikrodalga Yemek Kabı

1 Compartment Microwaveable Meal Container

Boyutlar/Dimension (LxWxH) 240x210x45

Koli İçi Adedi/Quantity Per Box (pcs) 300

Koli Ölçüleri/Box Dimensions (LxWxH)(mm) 505x262x640

Koli Hacmi/Box Volume (cbm) 0.085



EL376-GÖVDE

Tek Bölmeli Mikrodalga Yemek Kabı

1 Compartment Microwaveable Meal Container

Boyutlar/Dimension (LxWxH) 240x210x45

Koli İçi Adedi/Quantity Per Box (pcs) 300

Koli Ölçüleri/Box Dimensions (LxWxH)(mm) 505x262x640

Koli Hacmi/Box Volume (cbm) 0.085



EL376-KAPAK

Tek Bölmeli Kapak

1 Compartment Microwaveable Meal Container Lid

Boyutlar/Dimension (LxWxH) 240x210x30

Koli İçi Adedi/Quantity Per Box (pcs) 300

Koli Ölçüleri/Box Dimensions (LxWxH)(mm) 440x262x640

Koli Hacmi/Box Volume (cbm) 0.0688



EL377-GÖVDE-SİYAH

İki Bölmeli Mikrodalga Yemek Kabı

2 Compartment Microwaveable Meal Container

Boyutlar/Dimension (LxWxH) 240x210x45

Koli İçi Adedi/Quantity Per Box (pcs) 300

Koli Ölçüleri/Box Dimensions (LxWxH)(mm) 505x262x640

Koli Hacmi/Box Volume (cbm) 0.085



EL 377-GÖVDE

İki Bölmeli Mikrodalga Yemek Kabı

2 Compartment Microwaveable Meal Container

Boyutlar/Dimension (LxWxH) 240x210x45

Koli İçi Adedi/Quantity Per Box (pcs) 300

Koli Ölçüleri/Box Dimensions (LxWxH)(mm) 505x262x640

Koli Hacmi/Box Volume (cbm) 0.085



EL 377-KAPAK

İki Bölmeli Kapak

2 Compartment Microwaveable Meal Container Lid

Boyutlar/Dimension (LxWxH) 240x210x30

Koli İçi Adedi/Quantity Per Box (pcs) 300

Koli Ölçüleri/Box Dimensions (LxWxH)(mm) 410x262x640

Koli Hacmi/Box Volume (cbm) 0.0688



EL378-GÖVDE-SİYAH

3 Bölmeli Mikrodalga Yemek Kabı

3 Compartment Microwaveable Meal Container

Boyutlar/Dimension (LxWxH) 240x210x45

Koli İçi Adedi/Quantity Per Box (pcs) 300

Koli Ölçüleri/Box Dimensions (LxWxH)(mm) 505x262x640

Koli Hacmi/Box Volume (cbm) 0.085



EL 378-GÖVDE

3 Bölmeli Mikrodalga Yemek Kabı

3 Compartment Microwaveable Meal Container

Boyutlar/Dimension (LxWxH) 240x210x45

Koli İçi Adedi/Quantity Per Box (pcs) 300

Koli Ölçüleri/Box Dimensions (LxWxH)(mm) 505x262x640

Koli Hacmi/Box Volume (cbm) 0.085



EL378-KAPAK

3 Bölmeli Kapak

3 Compartment Microwaveable Meal Container Lid

Boyutlar/Dimension (LxWxH) 240x210x30

Koli İçi Adedi/Quantity Per Box (pcs) 300

Koli Ölçüleri/Box Dimensions (LxWxH)(mm) 410x262x640

Koli Hacmi/Box Volume (cbm) 0.0688



EL379

3 Bölmeli Mikrodalga Yemek Kabı

3 Compartment Microwaveable Meal Container

Boyutlar/Dimension (LxWxH) 210x240x45

Koli İçi Adedi/Quantity Per Box (pcs) 300

Koli Ölçüleri/Box Dimensions (LxWxH)(mm) 505x262x640

Koli Hacmi/Box Volume (cbm) 0.085

Kebap Kabi

Kabap Container





EL 484 KEBAP (S)

Kebab Kabi

Kabap Container

Boyutlar/Dimension (LxWxH)

217,5x314x40

Koli İçi Adedi/Quantity Per Box (pcs)

400

Koli Ölçüleri/Box Dimensions (LxWxH)(mm)

710x630x430

Koli Hacmi/Box Volume (cbm)

0.192



EL 484 KEBAP

Kebab Kabi

Kabap Container

Boyutlar/Dimension (LxWxH)

217,5x314x40

Koli İçi Adedi/Quantity Per Box (pcs)

400

Koli Ölçüleri/Box Dimensions (LxWxH)(mm)

710x630x430

Koli Hacmi/Box Volume (cbm)

0.192



EL 484-KAPAK

Kebab Kabi Kapak

Kabap Container Lid

Boyutlar/Dimension (LxWxH)

217,5x314x20

Koli İçi Adedi/Quantity Per Box (pcs)

400

Koli Ölçüleri/Box Dimensions (LxWxH)(mm)

630x630x430

Koli Hacmi/Box Volume (cbm)

0.170

Film Yapıştırırmalı Mikrodalga Yemek ve Et Kapları
Sealable Microwaveable Meal and Meat Containers

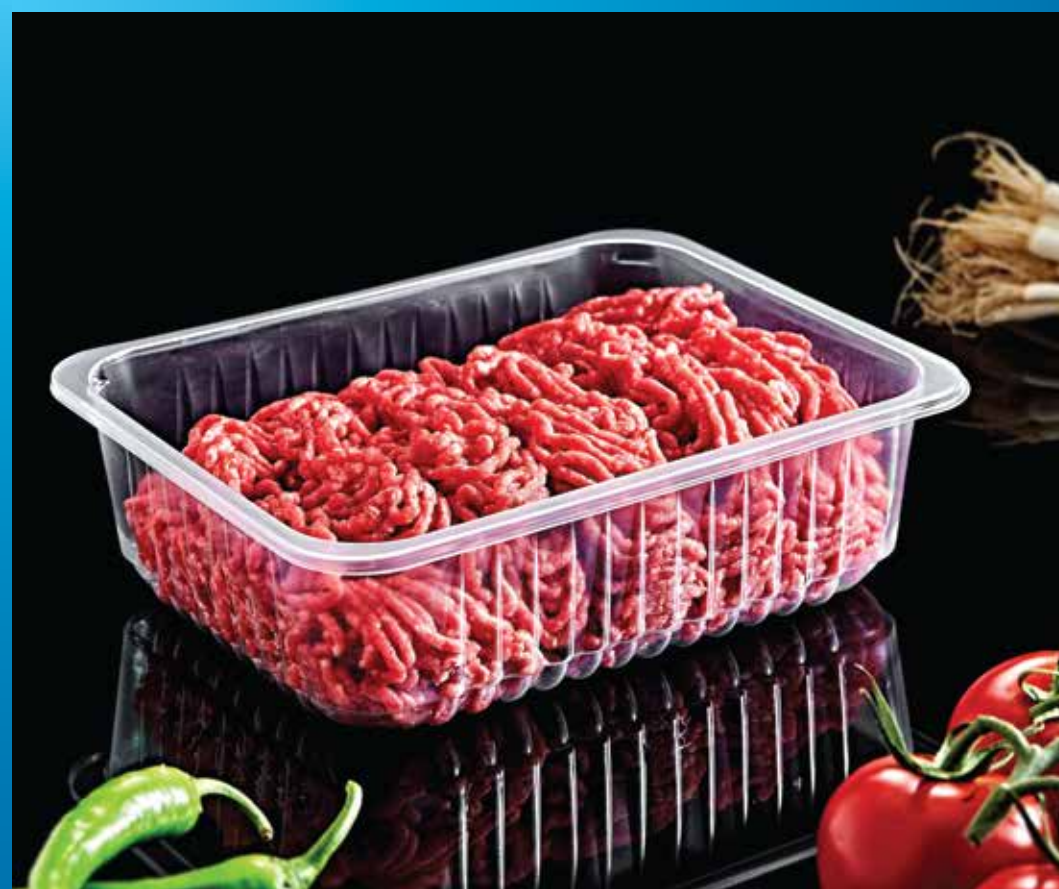



EL 471-SİYAH

Et Kabi

Meat Tray

Boyutlar/Dimension (LxWxH) 178x227x40

Koli İçi Adedi/Quantity Per Box (pcs) 400

Koli Ölçüleri/Box Dimensions (LxWxH)(mm) 780x380x470

Koli Hacmi/Box Volume (cbm) 0.1393



EL 471

Et Kabi

Meat Tray

Boyutlar/Dimension (LxWxH) 178x227x40

Koli İçi Adedi/Quantity Per Box (pcs) 400

Koli Ölçüleri/Box Dimensions (LxWxH)(mm) 780x380x470

Koli Hacmi/Box Volume (cbm) 0.1393



EL 472

Et Kabi

Meat Tray

Boyutlar/Dimension (LxWxH) 178x227x50

Koli İçi Adedi/Quantity Per Box (pcs) 400

Koli Ölçüleri/Box Dimensions (LxWxH)(mm) 780x380x470

Koli Hacmi/Box Volume (cbm) 0.1393



EL 473

Et Kabi

Meat Tray

Boyutlar/Dimension (LxWxH) 178x227x60

Koli İçi Adedi/Quantity Per Box (pcs) 400

Koli Ölçüleri/Box Dimensions (LxWxH)(mm) 780x380x470

Koli Hacmi/Box Volume (cbm) 0.1393



EL 477-SİYAH

2 Bölme Mikrodalga Yemek Kabı

2 Compartment Sealable Microwaveable Meal Container
Boyutlar/Dimension (LxWxH) 178x227x40
Koli İçi Adedi/Quantity Per Box (pcs) 400
Koli Ölçüleri/Box Dimensions (LxWxH)(mm) 600x380x470
Koli Hacmi/Box Volume (cbm) 0.1071



EL 477

2 Bölme Mikrodalga Yemek Kabı

2 Compartment Sealable Microwaveable Meal Container
Boyutlar/Dimension (LxWxH) 178x227x40
Koli İçi Adedi/Quantity Per Box (pcs) 400
Koli Ölçüleri/Box Dimensions (LxWxH)(mm) 600x380x470
Koli Hacmi/Box Volume (cbm) 0.1071



EL 479

6 Bölme Mikrodalga Yemek Kabı

6 Compartment Sealable Microwaveable Meal Container
Boyutlar/Dimension (LxWxH) 178x227x40
Koli İçi Adedi/Quantity Per Box (pcs) 400
Koli Ölçüleri/Box Dimensions (LxWxH)(mm) 600x380x470
Koli Hacmi/Box Volume (cbm) 0.1071



EL 478-SİYAH

3 Bölme Mikrodalga Yemek Kabı

3 Compartment Sealable Microwaveable Meal Container
Boyutlar/Dimension (LxWxH) 178x227x40
Koli İçi Adedi/Quantity Per Box (pcs) 400
Koli Ölçüleri/Box Dimensions (LxWxH)(mm) 600x380x470
Koli Hacmi/Box Volume (cbm) 0.1071



EL 478

3 Bölme Mikrodalga Yemek Kabı

3 Compartment Sealable Microwaveable Meal Container
Boyutlar/Dimension (LxWxH) 178x227x40
Koli İçi Adedi/Quantity Per Box (pcs) 400
Koli Ölçüleri/Box Dimensions (LxWxH)(mm) 600x380x470
Koli Hacmi/Box Volume (cbm) 0.1071



EL 475

4 Bölme Mikrodalga Yemek Kabı

4 Compartment Sealable Microwaveable Meal Container
Boyutlar/Dimension (LxWxH) 178x227x40
Koli İçi Adedi/Quantity Per Box (pcs) 800
Koli Ölçüleri/Box Dimensions (LxWxH)(mm) 510x460x590
Koli Hacmi/Box Volume (cbm) 0.1384

Film Yapıştırırmalı Mikrodalga Yemek ve Et Kapları
Sealable Microwaveable Meal and Meat Containers





EL 600-SİYAH

Boyutlar/Dimension (LxWxH)	190x144x16
Koli İçi Adedi/Quantity Per Box (pcs)	600
Koli Ölçüleri/Box Dimensions (LxWxH)(mm)	580x410x590
Koli Hacmi/Box Volume (cbm)	0.140



EL 600

Boyutlar/Dimension (LxWxH)	190x144x16
Koli İçi Adedi/Quantity Per Box (pcs)	600
Koli Ölçüleri/Box Dimensions (LxWxH)(mm)	580x410x590
Koli Hacmi/Box Volume (cbm)	0.140



EL 601-SİYAH

Boyutlar/Dimension (LxWxH)	190x144x20
Koli İçi Adedi/Quantity Per Box (pcs)	600
Koli Ölçüleri/Box Dimensions (LxWxH)(mm)	580x410x590
Koli Hacmi/Box Volume (cbm)	0.140



EL 601

Boyutlar/Dimension (LxWxH)	190x144x20
Koli İçi Adedi/Quantity Per Box (pcs)	600
Koli Ölçüleri/Box Dimensions (LxWxH)(mm)	580x410x590
Koli Hacmi/Box Volume (cbm)	0.140



EL 602-SİYAH

Boyutlar/Dimension (LxWxH)	190x144x30
Koli İçi Adedi/Quantity Per Box (pcs)	600
Koli Ölçüleri/Box Dimensions (LxWxH)(mm)	580x410x590
Koli Hacmi/Box Volume (cbm)	0.140



EL 602

Boyutlar/Dimension (LxWxH)	190x144x30
Koli İçi Adedi/Quantity Per Box (pcs)	600
Koli Ölçüleri/Box Dimensions (LxWxH)(mm)	580x410x590
Koli Hacmi/Box Volume (cbm)	0.140



EL 603-SİYAH

Boyutlar/Dimension (LxWxH)	190x144x50
Koli İçi Adedi/Quantity Per Box (pcs)	400
Koli Ölçüleri/Box Dimensions (LxWxH)(mm)	580x485x400
Koli Hacmi/Box Volume (cbm)	0.112



EL 603

Boyutlar/Dimension (LxWxH)	190x144x50
Koli İçi Adedi/Quantity Per Box (pcs)	400
Koli Ölçüleri/Box Dimensions (LxWxH)(mm)	580x485x400
Koli Hacmi/Box Volume (cbm)	0.112



EL 604-SİYAH

Boyutlar/Dimension (LxWxH)	190x144x55
Koli İçi Adedi/Quantity Per Box (pcs)	400
Koli Ölçüleri/Box Dimensions (LxWxH)(mm)	580x485x400
Koli Hacmi/Box Volume (cbm)	0.112



EL 604

Boyutlar/Dimension (LxWxH)	190x144x55
Koli İçi Adedi/Quantity Per Box (pcs)	400
Koli Ölçüleri/Box Dimensions (LxWxH)(mm)	580x485x400
Koli Hacmi/Box Volume (cbm)	0.112



EL 605-SİYAH

Boyutlar/Dimension (LxWxH)	190x144x65
Koli İçi Adedi/Quantity Per Box (pcs)	400
Koli Ölçüleri/Box Dimensions (LxWxH)(mm)	580x485x400
Koli Hacmi/Box Volume (cbm)	0.112



EL 605

Boyutlar/Dimension (LxWxH)	190x144x65
Koli İçi Adedi/Quantity Per Box (pcs)	400
Koli Ölçüleri/Box Dimensions (LxWxH)(mm)	580x485x400
Koli Hacmi/Box Volume (cbm)	0.112



EL 606-SIYAH

Boyutlar/Dimension (LxWxH)	190x144x75
Koli İçi Adedi/Quantity Per Box (pcs)	400
Koli Ölçüleri/Box Dimensions (LxWxH)(mm)	580x485x400
Koli Hacmi/Box Volume (cbm)	0.112



EL 606

Boyutlar/Dimension (LxWxH)	190x144x75
Koli İçi Adedi/Quantity Per Box (pcs)	400
Koli Ölçüleri/Box Dimensions (LxWxH)(mm)	580x485x400
Koli Hacmi/Box Volume (cbm)	0.112



Çikolata ve Bisküvi Seperatörleri

Chocolate and Biscuit Separators





EL 001

Boyutlar/Dimension (LxWxH) 28.5x9.5x7.4
Koli İçi Adedi/Quantity Per Box (pcs) 450
Koli Ölçüleri/Box Dimensions (LxWxH)(mm) 600x490x500
Koli Hacmi/Box Volume (cbm) 0.147



EL 053

Boyutlar/Dimension (LxWxH) 29.3x17x6.7
Koli İçi Adedi/Quantity Per Box (pcs) 450
Koli Ölçüleri/Box Dimensions (LxWxH)(mm) 600x490x500
Koli Hacmi/Box Volume (cbm) 0.147



EL 002

Boyutlar/Dimension (LxWxH) 25x8.5x6.4
Koli İçi Adedi/Quantity Per Box (pcs) 480
Koli Ölçüleri/Box Dimensions (LxWxH)(mm) 600x490x500
Koli Hacmi/Box Volume (cbm) 0.147

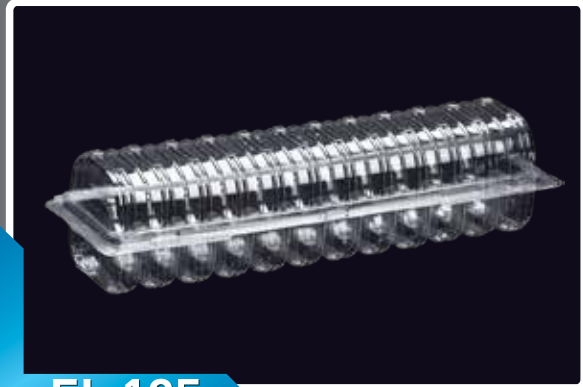

EL 195

Boyutlar/Dimension (LxWxH) 28.6x8.7x7
Koli İçi Adedi/Quantity Per Box (pcs) 450
Koli Ölçüleri/Box Dimensions (LxWxH)(mm) 600x490x500
Koli Hacmi/Box Volume (cbm) 0.147



EL 075-2

Boyutlar/Dimension (LxWxH)	24.2x9.1x7.5
Koli İçi Adedi/Quantity Per Box (pcs)	720
Koli Ölçüleri/Box Dimensions (LxWxH)(mm)	595x500x565
Koli Hacmi/Box Volume (cbm)	0.168



EL 192

Boyutlar/Dimension (LxWxH)	26.2x9x7.5
Koli İçi Adedi/Quantity Per Box (pcs)	500
Koli Ölçüleri/Box Dimensions (LxWxH)(mm)	600x490x500
Koli Hacmi/Box Volume (cbm)	0.147

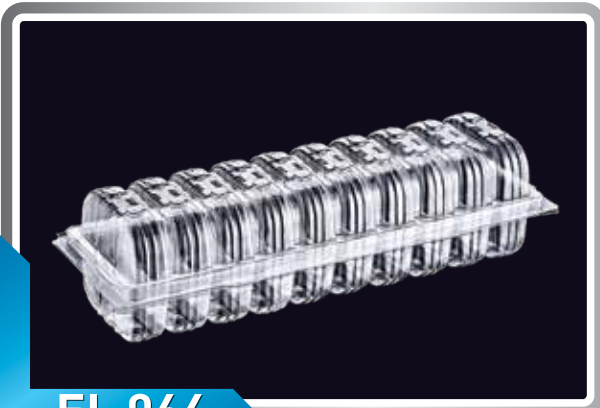

EL 064

Boyutlar/Dimension (LxWxH)	89x242x66
Koli İçi Adedi/Quantity Per Box (pcs)	600
Koli Ölçüleri/Box Dimensions (LxWxH)(mm)	595x500x565
Koli Hacmi/Box Volume (cbm)	0.168



EL 225

Boyutlar/Dimension (LxWxH)	25x8.7x6.5
Koli İçi Adedi/Quantity Per Box (pcs)	540
Koli Ölçüleri/Box Dimensions (LxWxH)(mm)	600x490x500
Koli Hacmi/Box Volume (cbm)	0.147



EL 184

Boyutlar/Dimension (LxWxH)	21.9x9x7
Koli İçi Adedi/Quantity Per Box (pcs)	600
Koli Ölçüleri/Box Dimensions (LxWxH)(mm)	600x490x500
Koli Hacmi/Box Volume (cbm)	0.147

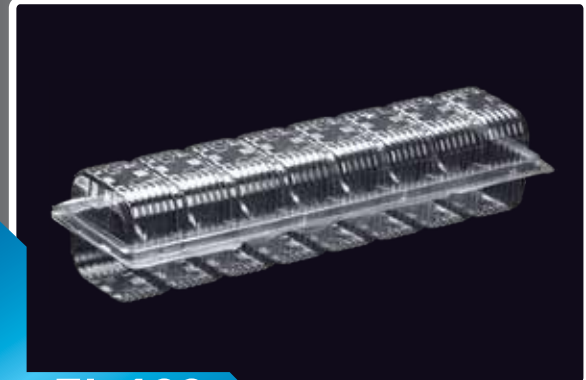

EL 138

Boyutlar/Dimension (LxWxH)	29.4x8.7x6.6
Koli İçi Adedi/Quantity Per Box (pcs)	450
Koli Ölçüleri/Box Dimensions (LxWxH)(mm)	600x490x500
Koli Hacmi/Box Volume (cbm)	0.147

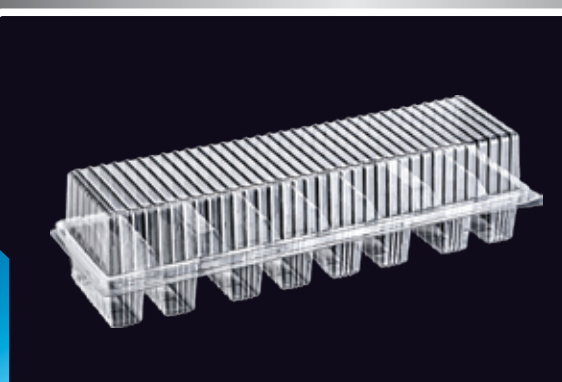

EL 227

Boyutlar/Dimension (LxWxH)	100x270x76
Koli İçi Adedi/Quantity Per Box (pcs)	400
Koli Ölçüleri/Box Dimensions (LxWxH)(mm)	600x490x500
Koli Hacmi/Box Volume (cbm)	0.147



EL 122

Boyutlar/Dimension (LxWxH)	19x8.7x5.5
Koli İçi Adedi/Quantity Per Box (pcs)	720
Koli Ölçüleri/Box Dimensions (LxWxH)(mm)	600x490x500
Koli Hacmi/Box Volume (cbm)	0.147



EL 251

Boyutlar/Dimension (LxWxH)	24.1x9.4x7.2
Koli İçi Adedi/Quantity Per Box (pcs)	528
Koli Ölçüleri/Box Dimensions (LxWxH)(mm)	595x500x565
Koli Hacmi/Box Volume (cbm)	0.168

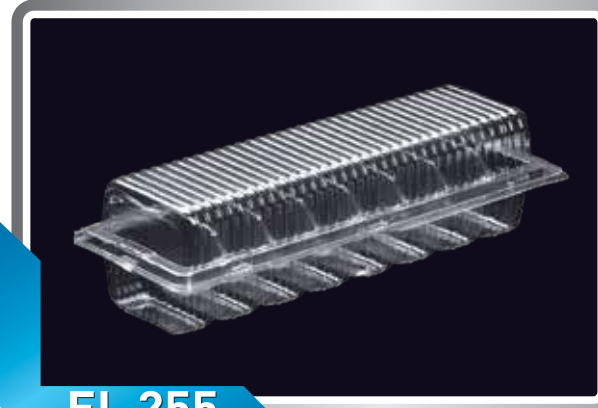

EL 255

Boyutlar/Dimension (LxWxH)	25x9x6.5
Koli İçi Adedi/Quantity Per Box (pcs)	312
Koli Ölçüleri/Box Dimensions (LxWxH)(mm)	600x490x500
Koli Hacmi/Box Volume (cbm)	0.147



EL 044

Boyutlar/Dimension (LxWxH)	23.9x8.8x7.5
Koli İçi Adedi/Quantity Per Box (pcs)	540
Koli Ölçüleri/Box Dimensions (LxWxH)(mm)	600x490x500
Koli Hacmi/Box Volume (cbm)	0.147



EL 250

Boyutlar/Dimension (LxWxH)	241x93x74
Koli İçi Adedi/Quantity Per Box (pcs)	528
Koli Ölçüleri/Box Dimensions (LxWxH)(mm)	595x500x565
Koli Hacmi/Box Volume (cbm)	0.168



EL 108

Boyutlar/Dimension (LxWxH) 21.6x6.2x5
Koli İçi Adedi/Quantity Per Box (pcs) 4166
Koli Ölçüleri/Box Dimensions (LxWxH)(mm) 600x490x500
Koli Hacmi/Box Volume (cbm) 0.147



EL 019

Boyutlar/Dimension (LxWxH) 170x138x46
Koli İçi Adedi/Quantity Per Box (pcs) 1248
Koli Ölçüleri/Box Dimensions (LxWxH)(mm) 595x500x565
Koli Hacmi/Box Volume (cbm) 0.168



EL 040

Boyutlar/Dimension (LxWxH) 16.6x9.2x7.6
Koli İçi Adedi/Quantity Per Box (pcs) 810
Koli Ölçüleri/Box Dimensions (LxWxH)(mm) 600x490x500
Koli Hacmi/Box Volume (cbm) 0.147





EL 008

Boyutlar/Dimension (LxWxH) 20.3x8x6.3
Koli İçi Adedi/Quantity Per Box (pcs) 3200
Koli Ölçüleri/Box Dimensions (LxWxH)(mm) 600x490x500
Koli Hacmi/Box Volume (cbm) 0.147



EL 005

Boyutlar/Dimension (LxWxH) 13x7.5x56
Koli İçi Adedi/Quantity Per Box (pcs) 4500
Koli Ölçüleri/Box Dimensions (LxWxH)(mm) 600x490x500
Koli Hacmi/Box Volume (cbm) 0.147



EL 043

Boyutlar/Dimension (LxWxH) 20.5x7.6x6.1
Koli İçi Adedi/Quantity Per Box (pcs) 3600
Koli Ölçüleri/Box Dimensions (LxWxH)(mm) 600x490x500
Koli Hacmi/Box Volume (cbm) 0.147

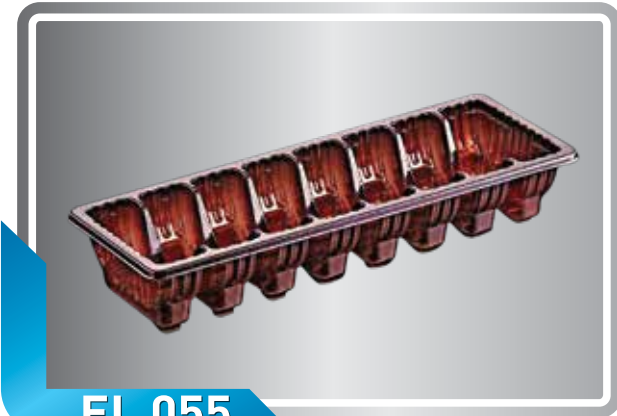

EL 055

Boyutlar/Dimension (LxWxH) 68x190x28
Koli İçi Adedi/Quantity Per Box (pcs) 2016
Koli Ölçüleri/Box Dimensions (LxWxH)(mm) 595x500x565
Koli Hacmi/Box Volume (cbm) 0.168



EL 278

Boyutlar/Dimension (LxWxH) 24.6x18.5x5
Koli İçi Adedi/Quantity Per Box (pcs) 600
Koli Ölçüleri/Box Dimensions (LxWxH)(mm) 600x490x500
Koli Hacmi/Box Volume (cbm) 0.147



EL 279

Boyutlar/Dimension (LxWxH) 26x20x1.6
Koli İçi Adedi/Quantity Per Box (pcs) 600
Koli Ölçüleri/Box Dimensions (LxWxH)(mm) 600x490x500
Koli Hacmi/Box Volume (cbm) 0.147



EL 294

Boyutlar/Dimension (LxWxH) 191x253x48
Koli İçi Adedi/Quantity Per Box (pcs) 480
Koli Ölçüleri/Box Dimensions (LxWxH)(mm) 400x400x540
Koli Hacmi/Box Volume (cbm) 0.0864



EL 295

Boyutlar/Dimension (LxWxH) 191x253x10
Koli İçi Adedi/Quantity Per Box (pcs) 600
Koli Ölçüleri/Box Dimensions (LxWxH)(mm) 400x400x540
Koli Hacmi/Box Volume (cbm) 0.0864



EL 280

Boyutlar/Dimension (LxWxH) 178x281x34
Koli İçi Adedi/Quantity Per Box (pcs) 200
Koli Ölçüleri/Box Dimensions (LxWxH)(mm) 605x370x570
Koli Hacmi/Box Volume (cbm) 0.128



EL 171

Boyutlar/Dimension (LxWxH) 18.2x13.7x4.5
Koli İçi Adedi/Quantity Per Box (pcs) 1900
Koli Ölçüleri/Box Dimensions (LxWxH)(mm) 600x490x500
Koli Hacmi/Box Volume (cbm) 0.147



EL 281

Boyutlar/Dimension (LxWxH) 18.5x18.5x6
Koli İçi Adedi/Quantity Per Box (pcs) 900
Koli Ölçüleri/Box Dimensions (LxWxH)(mm) 600x490x500
Koli Hacmi/Box Volume (cbm) 0.147



EL 222

Boyutlar/Dimension (LxWxH) 17.5x12.1x4
Koli İçi Adedi/Quantity Per Box (pcs) 1560
Koli Ölçüleri/Box Dimensions (LxWxH)(mm) 600x490x500
Koli Hacmi/Box Volume (cbm) 0.147



EL 223

Boyutlar/Dimension (LxWxH)	17x11.7x5.5
Koli İçi Adedi/Quantity Per Box (pcs)	1040
Koli Ölçüleri/Box Dimensions (LxWxH)(mm)	600x490x500
Koli Hacmi/Box Volume (cbm)	0.147



EL 006

Boyutlar/Dimension (LxWxH)	9.9x6.8x4
Koli İçi Adedi/Quantity Per Box (pcs)	7000
Koli Ölçüleri/Box Dimensions (LxWxH)(mm)	560x380x400
Koli Hacmi/Box Volume (cbm)	0.085



EL 011

Boyutlar/Dimension (LxWxH)	17x7.6x4
Koli İçi Adedi/Quantity Per Box (pcs)	3000
Koli Ölçüleri/Box Dimensions (LxWxH)(mm)	560x380x400
Koli Hacmi/Box Volume (cbm)	0.085



EL 047

Boyutlar/Dimension (LxWxH)	10.4x5.3x2.1
Koli İçi Adedi/Quantity Per Box (pcs)	6500
Koli Ölçüleri/Box Dimensions (LxWxH)(mm)	560x380x400
Koli Hacmi/Box Volume (cbm)	0.085



EL 080

Boyutlar/Dimension (LxWxH)	16.7x8.1x4.6
Koli İçi Adedi/Quantity Per Box (pcs)	2400
Koli Ölçüleri/Box Dimensions (LxWxH)(mm)	560x380x400
Koli Hacmi/Box Volume (cbm)	0.085



EL 144

Boyutlar/Dimension (LxWxH)	15.6x7.5x3.8
Koli İçi Adedi/Quantity Per Box (pcs)	3000
Koli Ölçüleri/Box Dimensions (LxWxH)(mm)	560x380x400
Koli Hacmi/Box Volume (cbm)	0.085



EL 291

Boyutlar/Dimension (LxWxH)	13.6x6.1x2
Koli İçi Adedi/Quantity Per Box (pcs)	4500
Koli Ölçüleri/Box Dimensions (LxWxH)(mm)	560x380x400
Koli Hacmi/Box Volume (cbm)	0.085



EL 163

Boyutlar/Dimension (LxWxH)	80x135x44
Koli İçi Adedi/Quantity Per Box (pcs)	3750
Koli Ölçüleri/Box Dimensions (LxWxH)(mm)	600x490x500
Koli Hacmi/Box Volume (cbm)	0.147



EL 269

Boyutlar/Dimension (LxWxH)	14.3x13x5.7
Koli İçi Adedi/Quantity Per Box (pcs)	2000
Koli Ölçüleri/Box Dimensions (LxWxH)(mm)	500x455x625
Koli Hacmi/Box Volume (cbm)	0.142



EL 128

Boyutlar/Dimension (LxWxH)	15.4x10.6x2.5
Koli İçi Adedi/Quantity Per Box (pcs)	4500
Koli Ölçüleri/Box Dimensions (LxWxH)(mm)	560x380x400
Koli Hacmi/Box Volume (cbm)	0.085

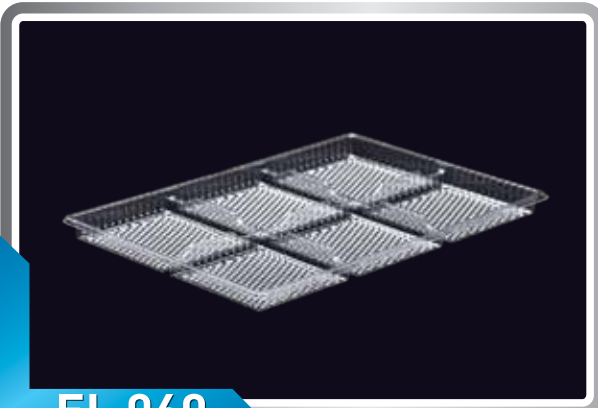

EL 060

Boyutlar/Dimension (LxWxH)	21.5x14.5x1.3
Koli İçi Adedi/Quantity Per Box (pcs)	1400
Koli Ölçüleri/Box Dimensions (LxWxH)(mm)	600x490x500
Koli Hacmi/Box Volume (cbm)	0.147



EL 176-1

Boyutlar/Dimension (LxWxH)	22.2x10.2x0.5
Koli İçi Adedi/Quantity Per Box (pcs)	2500
Koli Ölçüleri/Box Dimensions (LxWxH)(mm)	560x380x400
Koli Hacmi/Box Volume (cbm)	0.085



EL 290

Boyutlar/Dimension (LxWxH)	20x10.4x6.5
Koli İçi Adedi/Quantity Per Box (pcs)	1500
Koli Ölçüleri/Box Dimensions (LxWxH)(mm)	600x490x500
Koli Hacmi/Box Volume (cbm)	0.147



EL 238

Boyutlar/Dimension (LxWxH)	22.5x9.2x6
Koli İçi Adedi/Quantity Per Box (pcs)	900
Koli Ölçüleri/Box Dimensions (LxWxH)(mm)	570x500x430
Koli Hacmi/Box Volume (cbm)	0.122



EL 010

Boyutlar/Dimension (LxWxH)	15.7x15.7x4
Koli İçi Adedi/Quantity Per Box (pcs)	1150
Koli Ölçüleri/Box Dimensions (LxWxH)(mm)	570x500x430
Koli Hacmi/Box Volume (cbm)	0.122



EL 341

Boyutlar/Dimension (LxWxH)	198x169x30
Koli İçi Adedi/Quantity Per Box (pcs)	1400
Koli Ölçüleri/Box Dimensions (LxWxH)(mm)	560x380x400
Koli Hacmi/Box Volume (cbm)	0.085



EL 012S

Boyutlar/Dimension (LxWxH) 20.1x16.2x2.7
Koli İçi Adedi/Quantity Per Box (pcs) 1100
Koli Ölçüleri/Box Dimensions (LxWxH)(mm) 560x380x400
Koli Hacmi/Box Volume (cbm) 0.085



EL 012K

Boyutlar/Dimension (LxWxH) 20.1x16.2x2.7
Koli İçi Adedi/Quantity Per Box (pcs) 1100
Koli Ölçüleri/Box Dimensions (LxWxH)(mm) 560x380x400
Koli Hacmi/Box Volume (cbm) 0.085



EL 038-1

Boyutlar/Dimension (LxWxH) 15.7x15.7x2.8
Koli İçi Adedi/Quantity Per Box (pcs) 1800
Koli Ölçüleri/Box Dimensions (LxWxH)(mm) 560x380x400
Koli Hacmi/Box Volume (cbm) 0.085



EL 076

Boyutlar/Dimension (LxWxH) 15x10.8x3
Koli İçi Adedi/Quantity Per Box (pcs) 2900
Koli Ölçüleri/Box Dimensions (LxWxH)(mm) 560x380x400
Koli Hacmi/Box Volume (cbm) 0.085



EL 054

Boyutlar/Dimension (LxWxH) 163x147x36
Koli İçi Adedi/Quantity Per Box (pcs) 720
Koli Ölçüleri/Box Dimensions (LxWxH)(mm) 600x490x500
Koli Hacmi/Box Volume (cbm) 0.1470



EL 076

Boyutlar/Dimension (LxWxH) 104x149x30
Koli İçi Adedi/Quantity Per Box (pcs) 1320
Koli Ölçüleri/Box Dimensions (LxWxH)(mm) 560x380x400
Koli Hacmi/Box Volume (cbm) 0.085



EL 216

Boyutlar/Dimension (LxWxH) 15.2x6.2x2.5
Koli İçi Adedi/Quantity Per Box (pcs) 7500
Koli Ölçüleri/Box Dimensions (LxWxH)(mm) 600x490x500
Koli Hacmi/Box Volume (cbm) 0.147



EL 237

Boyutlar/Dimension (LxWxH) 16x5.8x3
Koli İçi Adedi/Quantity Per Box (pcs) 2500
Koli Ölçüleri/Box Dimensions (LxWxH)(mm) 600x490x500
Koli Hacmi/Box Volume (cbm) 0.147

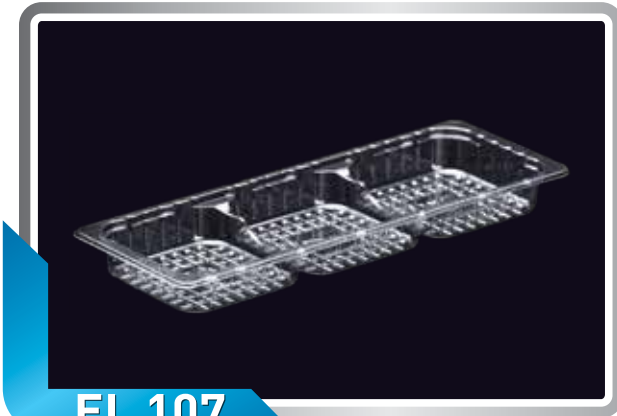

EL 107

Boyutlar/Dimension (LxWxH) 16.1x5.7x1.5
Koli İçi Adedi/Quantity Per Box (pcs) 4500
Koli Ölçüleri/Box Dimensions (LxWxH)(mm) 600x490x500
Koli Hacmi/Box Volume (cbm) 0.147



EL 274

Boyutlar/Dimension (LxWxH)	11.1x5.7x1.4
Koli İçi Adedi/Quantity Per Box (pcs)	6140
Koli Ölçüleri/Box Dimensions (LxWxH)(mm)	600x490x500
Koli Hacmi/Box Volume (cbm)	0.147



EL 217

Boyutlar/Dimension (LxWxH)	10.2x6.1x3
Koli İçi Adedi/Quantity Per Box (pcs)	5290
Koli Ölçüleri/Box Dimensions (LxWxH)(mm)	600x490x500
Koli Hacmi/Box Volume (cbm)	0.147



EL 212

Boyutlar/Dimension (LxWxH)	11.6x6.1x2.7
Koli İçi Adedi/Quantity Per Box (pcs)	5400
Koli Ölçüleri/Box Dimensions (LxWxH)(mm)	560x380x400
Koli Hacmi/Box Volume (cbm)	0.085



EL 058

Boyutlar/Dimension (LxWxH)	7.7x15x2
Koli İçi Adedi/Quantity Per Box (pcs)	4500
Koli Ölçüleri/Box Dimensions (LxWxH)(mm)	600x490x500
Koli Hacmi/Box Volume (cbm)	0.147



EL 020

Boyutlar/Dimension (LxWxH)	55x197.5x57
Koli İçi Adedi/Quantity Per Box (pcs)	2700
Koli Ölçüleri/Box Dimensions (LxWxH)(mm)	600x490x500
Koli Hacmi/Box Volume (cbm)	0.147



EL 293

Boyutlar/Dimension (LxWxH)	115x254x30
Koli İçi Adedi/Quantity Per Box (pcs)	1400
Koli Ölçüleri/Box Dimensions (LxWxH)(mm)	540x435x515
Koli Hacmi/Box Volume (cbm)	0.121



EL 189

Boyutlar/Dimension (LxWxH)	20.2x13.5x2.8
Koli İçi Adedi/Quantity Per Box (pcs)	1050
Koli Ölçüleri/Box Dimensions (LxWxH)(mm)	560x380x400
Koli Hacmi/Box Volume (cbm)	0.085



EL 162

Boyutlar/Dimension (LxWxH)	82x260x58
Koli İçi Adedi/Quantity Per Box (pcs)	1000
Koli Ölçüleri/Box Dimensions (LxWxH)(mm)	570x500x430
Koli Hacmi/Box Volume (cbm)	0.123

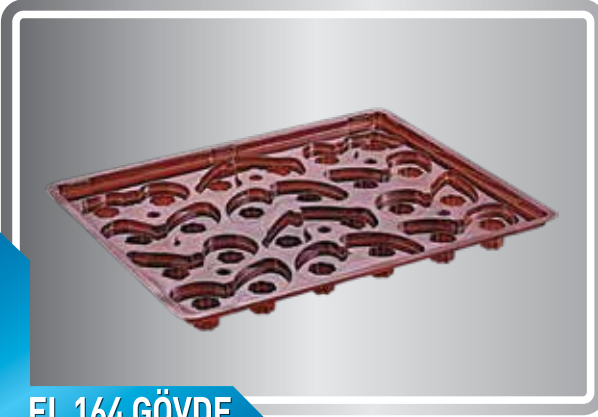
**EL 164 GÖVDE**

Boyutlar/Dimension (LxWxH)	208x258x26
Koli İçi Adedi/Quantity Per Box (pcs)	280
Koli Ölçüleri/Box Dimensions (LxWxH)(mm)	570x500x430
Koli Hacmi/Box Volume (cbm)	0.123

**EL 164 KAPAK**

Boyutlar/Dimension (LxWxH)	208x258x11
Koli İçi Adedi/Quantity Per Box (pcs)	400
Koli Ölçüleri/Box Dimensions (LxWxH)(mm)	570x500x430
Koli Hacmi/Box Volume (cbm)	0.123

**EL 165 GÖVDE**

Boyutlar/Dimension (LxWxH)	208x258x26
Koli İçi Adedi/Quantity Per Box (pcs)	360
Koli Ölçüleri/Box Dimensions (LxWxH)(mm)	570x500x430
Koli Hacmi/Box Volume (cbm)	0.123

**EL 165 KAPAK**

Boyutlar/Dimension (LxWxH)	208x258x11
Koli İçi Adedi/Quantity Per Box (pcs)	400
Koli Ölçüleri/Box Dimensions (LxWxH)(mm)	570x500x430
Koli Hacmi/Box Volume (cbm)	0.123



EL 131

Boyutlar/Dimension (LxWxH)	208x258x30
Koli İçi Adedi/Quantity Per Box (pcs)	600
Koli Ölçüleri/Box Dimensions (LxWxH)(mm)	600x490x500
Koli Hacmi/Box Volume (cbm)	0.147

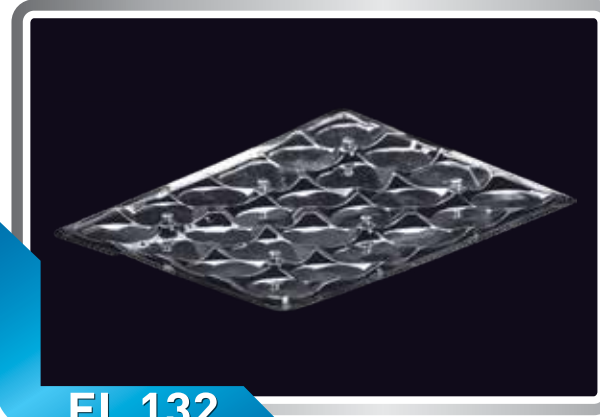

EL 132

Boyutlar/Dimension (LxWxH)	25.6x20.7x0.1
Koli İçi Adedi/Quantity Per Box (pcs)	600
Koli Ölçüleri/Box Dimensions (LxWxH)(mm)	600x490x500
Koli Hacmi/Box Volume (cbm)	0.147



EL 046

Boyutlar/Dimension (LxWxH)	24.3x21.2x2.8
Koli İçi Adedi/Quantity Per Box (pcs)	720
Koli Ölçüleri/Box Dimensions (LxWxH)(mm)	600x490x500
Koli Hacmi/Box Volume (cbm)	0.147



EL 174

Boyutlar/Dimension (LxWxH)	15.7x9.6x1.1
Koli İçi Adedi/Quantity Per Box (pcs)	1000
Koli Ölçüleri/Box Dimensions (LxWxH)(mm)	560x380x400
Koli Hacmi/Box Volume (cbm)	0.085

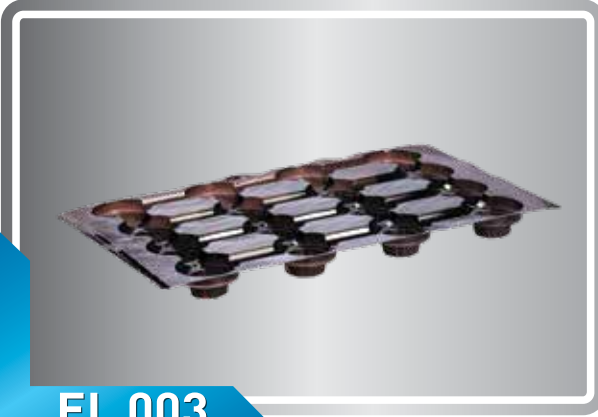
**EL 003**

Boyutlar/Dimension (LxWxH)	20.6x33.1x2.3
Koli İçi Adedi/Quantity Per Box (pcs)	1000
Koli Ölçüleri/Box Dimensions (LxWxH)(mm)	600x490x500
Koli Hacmi/Box Volume (cbm)	0.147

**EL 033**

Boyutlar/Dimension (LxWxH)	21x17x2.5
Koli İçi Adedi/Quantity Per Box (pcs)	1200
Koli Ölçüleri/Box Dimensions (LxWxH)(mm)	600x490x500
Koli Hacmi/Box Volume (cbm)	0.147

**EL 131**

Boyutlar/Dimension (LxWxH)	24.2x9.1x7.5
Koli İçi Adedi/Quantity Per Box (pcs)	720
Koli Ölçüleri/Box Dimensions (LxWxH)(mm)	595x500x565
Koli Hacmi/Box Volume (cbm)	0.168

**EL 073**

Boyutlar/Dimension (LxWxH)	24.4x31x3
Koli İçi Adedi/Quantity Per Box (pcs)	400
Koli Ölçüleri/Box Dimensions (LxWxH)(mm)	600x490x500
Koli Hacmi/Box Volume (cbm)	0.147



EL 264

Boyutlar/Dimension (LxWxH) 11.4x9x1.2
Koli İçi Adedi/Quantity Per Box (pcs) 4800
Koli Ölçüleri/Box Dimensions (LxWxH)(mm) 560x380x400
Koli Hacmi/Box Volume (cbm) 0.085



EL 268

Boyutlar/Dimension (LxWxH) 8.7x7.4x1.5
Koli İçi Adedi/Quantity Per Box (pcs) 6200
Koli Ölçüleri/Box Dimensions (LxWxH)(mm) 600x490x500
Koli Hacmi/Box Volume (cbm) 0.147



EL 056

Boyutlar/Dimension (LxWxH) 9.2x7.6x1.4
Koli İçi Adedi/Quantity Per Box (pcs) 5600
Koli Ölçüleri/Box Dimensions (LxWxH)(mm) 560x380x400
Koli Hacmi/Box Volume (cbm) 0.085



EL 199

Boyutlar/Dimension (LxWxH) 12.4x8.4x1.5
Koli İçi Adedi/Quantity Per Box (pcs) 5000
Koli Ölçüleri/Box Dimensions (LxWxH)(mm) 560x380x400
Koli Hacmi/Box Volume (cbm) 0.085



EL 168

Boyutlar/Dimension (LxWxH) 15.7x10.2x1.6
Koli İçi Adedi/Quantity Per Box (pcs) 2750
Koli Ölçüleri/Box Dimensions (LxWxH)(mm) 600x490x500
Koli Hacmi/Box Volume (cbm) 0.1470

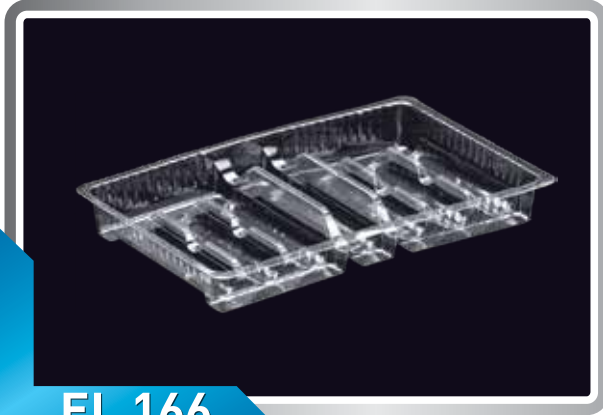

EL 166

Boyutlar/Dimension (LxWxH) 14x9x1.7
 Koli İçi Adedi/Quantity Per Box (pcs) 3000
 Koli Ölçüleri/Box Dimensions (LxWxH)(mm) 600x490x500
 Koli Hacmi/Box Volume (cbm) 0.147



EL 111

Boyutlar/Dimension (LxWxH) 14.5x8.5x1.6
 Koli İçi Adedi/Quantity Per Box (pcs) 5405
 Koli Ölçüleri/Box Dimensions (LxWxH)(mm) 600x490x500
 Koli Hacmi/Box Volume (cbm) 0.147



EL 198

Boyutlar/Dimension (LxWxH) 16.7x11.4x1.5
 Koli İçi Adedi/Quantity Per Box (pcs) 3300
 Koli Ölçüleri/Box Dimensions (LxWxH)(mm) 600x490x500
 Koli Hacmi/Box Volume (cbm) 0.147

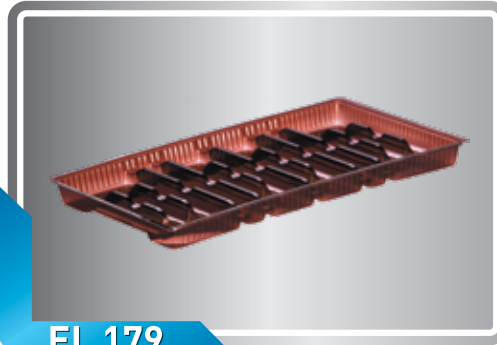

EL 179

Boyutlar/Dimension (LxWxH) 23x12.8x2.7
 Koli İçi Adedi/Quantity Per Box (pcs) 1500
 Koli Ölçüleri/Box Dimensions (LxWxH)(mm) 600x490x500
 Koli Hacmi/Box Volume (cbm) 0.147



EL 260

Boyutlar/Dimension (LxWxH) 157x90x1.6
 Koli İçi Adedi/Quantity Per Box (pcs) 2590
 Koli Ölçüleri/Box Dimensions (LxWxH)(mm) 600x490x500
 Koli Hacmi/Box Volume (cbm) 0.1470



EL 096

Boyutlar/Dimension (LxWxH) 9x7.4x1.7
Koli İçi Adedi/Quantity Per Box (pcs) 5882
Koli Ölçüleri/Box Dimensions (LxWxH)(mm) 600x490x500
Koli Hacmi/Box Volume (cbm) 0.147

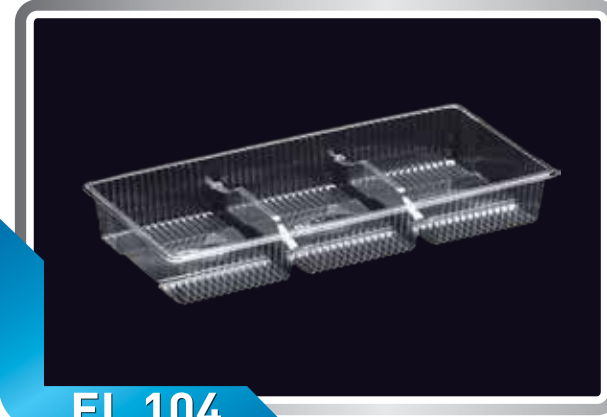

EL 104

Boyutlar/Dimension (LxWxH) 18.7x8.8x2.5
Koli İçi Adedi/Quantity Per Box (pcs) 4000
Koli Ölçüleri/Box Dimensions (LxWxH)(mm) 600x490x500
Koli Hacmi/Box Volume (cbm) 0.147



EL 094

Boyutlar/Dimension (LxWxH) 16x8.8x2.3
Koli İçi Adedi/Quantity Per Box (pcs) 4500
Koli Ölçüleri/Box Dimensions (LxWxH)(mm) 600x490x500
Koli Hacmi/Box Volume (cbm) 0.147



EL 090

Boyutlar/Dimension (LxWxH) 11.8x5.7x1.5
Koli İçi Adedi/Quantity Per Box (pcs) 6000
Koli Ölçüleri/Box Dimensions (LxWxH)(mm) 600x490x500
Koli Hacmi/Box Volume (cbm) 0.147



EL 091

Boyutlar/Dimension (LxWxH) 12.2x4x4.13
Koli İçi Adedi/Quantity Per Box (pcs) 12413
Koli Ölçüleri/Box Dimensions (LxWxH)(mm) 560x380x400
Koli Hacmi/Box Volume (cbm) 0.085



EL 092

Boyutlar/Dimension (LxWxH)	12.5x4x1.2
Koli İçi Adedi/Quantity Per Box (pcs)	8065
Koli Ölçüleri/Box Dimensions (LxWxH)(mm)	600x490x500
Koli Hacmi/Box Volume (cbm)	0.147



EL 105

Boyutlar/Dimension (LxWxH)	15.9x7.6x2.4
Koli İçi Adedi/Quantity Per Box (pcs)	4500
Koli Ölçüleri/Box Dimensions (LxWxH)(mm)	600x490x500
Koli Hacmi/Box Volume (cbm)	0.147



EL 259-1

Boyutlar/Dimension (LxWxH)	18x9.2x2.6
Koli İçi Adedi/Quantity Per Box (pcs)	4320
Koli Ölçüleri/Box Dimensions (LxWxH)(mm)	600x490x500
Koli Hacmi/Box Volume (cbm)	0.147



EL 103

Boyutlar/Dimension (LxWxH)	16.1x8.8x2.5
Koli İçi Adedi/Quantity Per Box (pcs)	4590
Koli Ölçüleri/Box Dimensions (LxWxH)(mm)	600x490x500
Koli Hacmi/Box Volume (cbm)	0.147



EL 102

Boyutlar/Dimension (LxWxH)	19.3x9.2x2.5
Koli İçi Adedi/Quantity Per Box (pcs)	3600
Koli Ölçüleri/Box Dimensions (LxWxH)(mm)	600x490x500
Koli Hacmi/Box Volume (cbm)	0.147

**EL 288**

Boyutlar/Dimension (LxWxH)	24.8x16.3x7.4
Koli İçi Adedi/Quantity Per Box (pcs)	750
Koli Ölçüleri/Box Dimensions (LxWxH)(mm)	600x490x500
Koli Hacmi/Box Volume (cbm)	0.147

**EL 232**

Boyutlar/Dimension (LxWxH)	20.3x13.8x4.5
Koli İçi Adedi/Quantity Per Box (pcs)	720
Koli Ölçüleri/Box Dimensions (LxWxH)(mm)	600x490x500
Koli Hacmi/Box Volume (cbm)	0.147

**EL 215**

Boyutlar/Dimension (LxWxH)	22.3x15.1x6.8
Koli İçi Adedi/Quantity Per Box (pcs)	300
Koli Ölçüleri/Box Dimensions (LxWxH)(mm)	600x490x500
Koli Hacmi/Box Volume (cbm)	0.147





EL 021

Boyutlar/Dimension (LxWxH)	19.2x15x3.5
Koli İçi Adedi/Quantity Per Box (pcs)	1000
Koli Ölçüleri/Box Dimensions (LxWxH)(mm)	600x490x500
Koli Hacmi/Box Volume (cbm)	0.147



EL 230

Boyutlar/Dimension (LxWxH)	29.6x20.5x3.4
Koli İçi Adedi/Quantity Per Box (pcs)	280
Koli Ölçüleri/Box Dimensions (LxWxH)(mm)	600x490x500
Koli Hacmi/Box Volume (cbm)	0.147



EL 210S

Boyutlar/Dimension (LxWxH)	15.2x10.7x2.8
Koli İçi Adedi/Quantity Per Box (pcs)	3000
Koli Ölçüleri/Box Dimensions (LxWxH)(mm)	600x490x500
Koli Hacmi/Box Volume (cbm)	0.147



EL 210

Boyutlar/Dimension (LxWxH)	15.2x10.7x2.8
Koli İçi Adedi/Quantity Per Box (pcs)	3000
Koli Ölçüleri/Box Dimensions (LxWxH)(mm)	600x490x500
Koli Hacmi/Box Volume (cbm)	0.147



EL 032

Boyutlar/Dimension (LxWxH)	11.9x9.1x3.1
Koli İçi Adedi/Quantity Per Box (pcs)	2400
Koli Ölçüleri/Box Dimensions (LxWxH)(mm)	600x490x500
Koli Hacmi/Box Volume (cbm)	0.147



EL 117

Boyutlar/Dimension (LxWxH)	9.2x6x1.3
Koli İçi Adedi/Quantity Per Box (pcs)	13000
Koli Ölçüleri/Box Dimensions (LxWxH)(mm)	560x380x400
Koli Hacmi/Box Volume (cbm)	0.085



EL 152

Boyutlar/Dimension (LxWxH)	15x6.5x1.9
Koli İçi Adedi/Quantity Per Box (pcs)	5000
Koli Ölçüleri/Box Dimensions (LxWxH)(mm)	560x380x400
Koli Hacmi/Box Volume (cbm)	0.085



EL 151

Boyutlar/Dimension (LxWxH)	15x15.5x1.8
Koli İçi Adedi/Quantity Per Box (pcs)	6500
Koli Ölçüleri/Box Dimensions (LxWxH)(mm)	560x380x400
Koli Hacmi/Box Volume (cbm)	0.085



EL 155

Boyutlar/Dimension (LxWxH)	14.7x5.9x1.3
Koli İçi Adedi/Quantity Per Box (pcs)	5600
Koli Ölçüleri/Box Dimensions (LxWxH)(mm)	560x380x400
Koli Hacmi/Box Volume (cbm)	0.085



EL 148

Boyutlar/Dimension (LxWxH) 22.2x4.2x1.8
Koli İçi Adedi/Quantity Per Box (pcs) 3230
Koli Ölçüleri/Box Dimensions (LxWxH)(mm) 600x490x500
Koli Hacmi/Box Volume (cbm) 0.147



EL 149

Boyutlar/Dimension (LxWxH) 22.2x4.2x2
Koli İçi Adedi/Quantity Per Box (pcs) 3230
Koli Ölçüleri/Box Dimensions (LxWxH)(mm) 600x490x500
Koli Hacmi/Box Volume (cbm) 0.122



EL 183

Boyutlar/Dimension (LxWxH) 15x4.3x2
Koli İçi Adedi/Quantity Per Box (pcs) 10000
Koli Ölçüleri/Box Dimensions (LxWxH)(mm) 560x380x400
Koli Hacmi/Box Volume (cbm) 0.085



Sertifikalar / Certificates



Intertek
Total Quality Assured.

CERTIFICATE OF REGISTRATION

Intertek Certification Ltd (UKAS 014) certifies that having conducted an audit for the **Scope of Activities**: Extrusion and casting-based production of PET and PP films, production of plastic (PET, PP) cups and closures produced forming with thermoform technique for food products,
with the Exclusions from Scope: None
in the Product Categories: 04 - Rigid plastics forming
at

ELTRON PLASTIK ELEKTROMEKANİK SAN. VE TIC. LTD. STI.

BRCGS Site Code: 7260528
Site Address: ÖRNEK MAHALLESİ ERZURUM KONGRE
CADDESİ BİRLİK İS MERKEZİ NO:7/1 34517- ESENYURT
İSTANBUL TURKEY
has achieved Grade: A
and meets the Requirements set out in the
**GLOBAL STANDARD FOR PACKAGING MATERIALS
ISSUE 6: AUGUST 2019**
Audit Programme: Announced



Calin Moldovean
President Business Assurance
Intertek Certification Limited, 80A Victory
Park, Victory Road, Derby DE24 8ZP, United
Kingdom
Intertek Certification Limited is a
UKAS accredited body under
schedule of accreditation no. 014.



In the issuance of this certificate, Intertek assumes no liability to any party other than to the Client, and this only in accordance with the agreed scope of certification Agreement. The certificate's validity is subject to the organisation maintaining this system in accordance with Product's BRC Regulations. The certificate remains the property of Intertek, to whom it must be returned upon request. Validity may be confirmed via email at certification@intertek.com or by scanning the code in this QR with a smartphone. If you would like to feedback a comment on the BRC Global Standard or the audit process, then go to www.brc.com or email enquiries@brcglobalstandards.com or call the BRC Helpline on +44 (0)20 7712 1000. Visit the BRC Directory (www.brc-directory.com) to validate the authenticity of this certificate.





T.C.
İSTANBUL VALİLİĞİ
İL GIDA, TARIM VE HAYVANCILIK MÜDÜRLÜĞÜ
İŞLETME KAYIT BELGESİ

Kayıt No	TR-34-K-034634
İşletmecinin Adı-Soyadı / Tüzel Kişinin Adı	Eltron Plastik Elektromekanik Sanayi Ve Ticaret Limited Şirketi-Esenyurt
İşletmenin Ticaret Unvanı	Eltron Plastik Elektromekanik Sanayi Ve Ticaret Limited Şirketi-Esenyurt
Şirket, Kurum, Kuruluş Merkez Adresi	Örnek Mah. Erzurum Kongre Cad. No:7/1 Merkez Esenyurt - İstanbul / Türkiye
İşletmenin Adresi	Örnek Mah. Erzurum Kongre Cad. No:7/1 Merkez Esenyurt - İstanbul / Türkiye
İşletmenin Faaliyet Konusu	Plastik esaslı madde ve malzeme üretimi
Belgenin İlk Veriliş Tarihi	18/03/2013
Belgenin Değişiklik Tarihi	

İş bu belge, 5996 sayılı Kanununun 30 uncu maddesine dayanılarak düzenlenmiştir.



Kasım PIRAL
İl Müdürü



eltron

The logo for 'eltron' features the word 'eltron' in a bold, white, lowercase sans-serif font. The text is centered and partially enclosed by a light blue, swooping graphic element that forms a partial oval around the letters 'l', 't', 'r', and 'o'.

eltron



Örnek Mah.Erzurum Kongre Cad.
No.7/1 Esenyurt / İSTANBUL
Telefon :+90 (212) 671 43 72
+90 (212) 671 43 73
Faks :+90 (212) 671 43 74
E-Posta :info@eltronpls.com
export@eltronpls.com

eltron
PLASTİK ELEKTROMEKANİK LTD. ŞTİ.

